

- **RF Filter for Mobile Communication Applications**
- **Low Insertion Loss**
- **3.0 x 3.0 x 1.3 mm Surface-Mount Case**
- **No Matching Circuit Required**
- **Complies with Directive 2002/95/EC (RoHS)**
- **Moisture Sensitivity Level: 1**

**SF1182B**

**836.5 MHz**  
**SAW Filter**

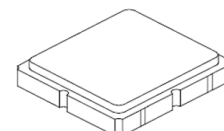

**SM3030-6**

**Absolute Maximum Ratings**

Rating	Value	Units
Maximum Incident Power in Passband	+10	dBm
Maximum DC Voltage Between any 2 Terminals	0	VDC
Storage Temperature Range	-40 to +85	°C
Maximum Soldering Profile	265 °C for 10 s	

Characteristic	Sym	Notes	Min	Typ	Max	Units
Nominal Operating Frequency	$f_C$			836.5		MHz
Insertion Loss, 824-849 MHz	IL			2.1	3.0	dB
Amplitude Ripple, p-p, 824-849 MHz				1.2	2.0	
Attenuation Referenced to IL:						dB
DC to 800 MHz			23	26		
869 to 894 MHz			29	32		
978 to 1006 MHz			25	28		
1050 to 2500 MHz			15	18		
VSWR, 824-849 MHz				1.8:1	2.3:1	
Source impedance	$Z_S$			50		$\Omega$
Load impedance	$Z_L$			50		$\Omega$
Operating Temperature	$T_A$		-30		+85	°C
Single Ended Input / Output, Impedance match	No matching network required for operation at 50 ohms					
Case Style	SM3030-6 3 x 3 mm Nominal Footprint					
Lid Symbolization (Y =year, WW=week, S = Shift)	448 <u>YWWS</u>					

 **CAUTION: Electrostatic Sensitive Device. Observe precautions for handling.**

**NOTES:**

1. The design, manufacturing process, and specifications of this device are subject to change.
2. US or International patents may apply.
3. RoHS compliant from the first date of manufacture.

## Electrical Connections

Connection	Terminals
Input	2
Output	5
Ground	All others

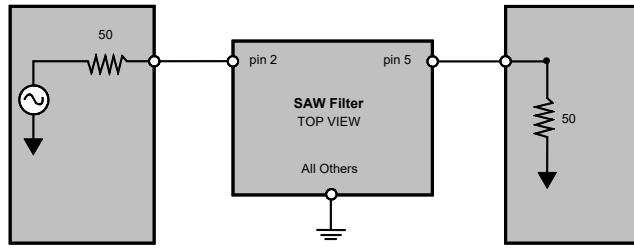

## Filter Response Plots

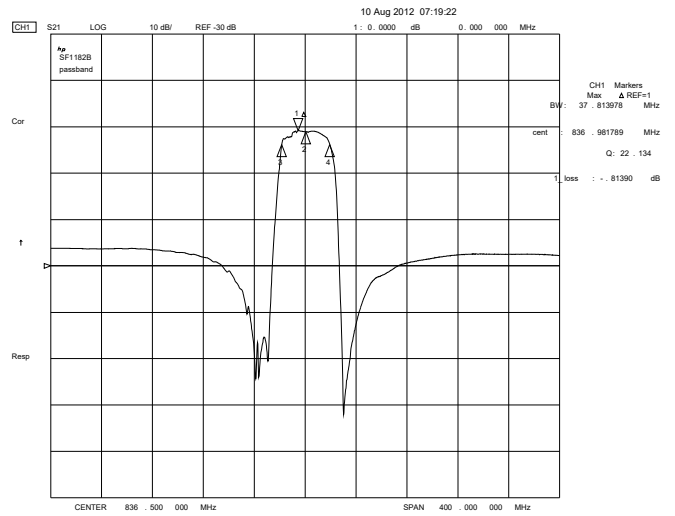
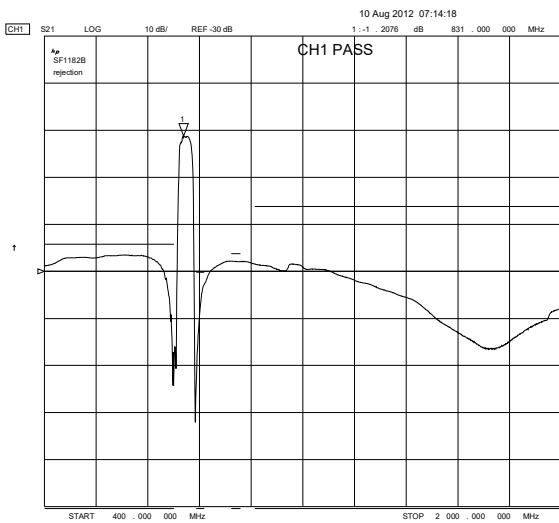

# SM3030-6 Case

## 6-Terminal Ceramic Surface-Mount Case 3.0 X 3.0 mm Nominal Footprint

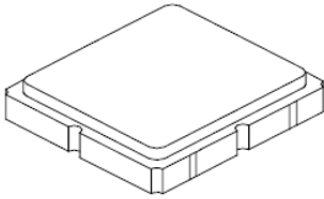

### Case Dimensions

Dimension	mm			Inches		
	Min	Nom	Max	Min	Nom	Max
A		3.0			0.118	
B		3.0			0.118	
C		1.3			0.051	
D		0.9			0.035	
E		2.54			0.100	
F		1.6			0.063	
G		0.85			0.033	
H		1.5			0.059	
I		0.6			0.024	
J		1.3			0.051	

### Electrical Connections

Connection		Terminals
Port 1	Single Ended Input	2
Port 2	Single Ended Output	5
	Ground	All others
Single-ending Operation Only		
Dot indicates Pin 1		

### TOP VIEW

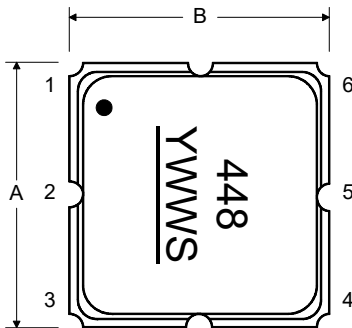

### BOTTOM VIEW

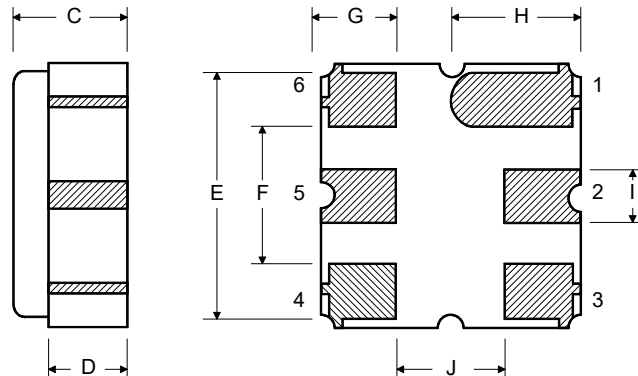

## Tape and Reel Specifications

Tape and Reel Standard per ANSI/EIA-481

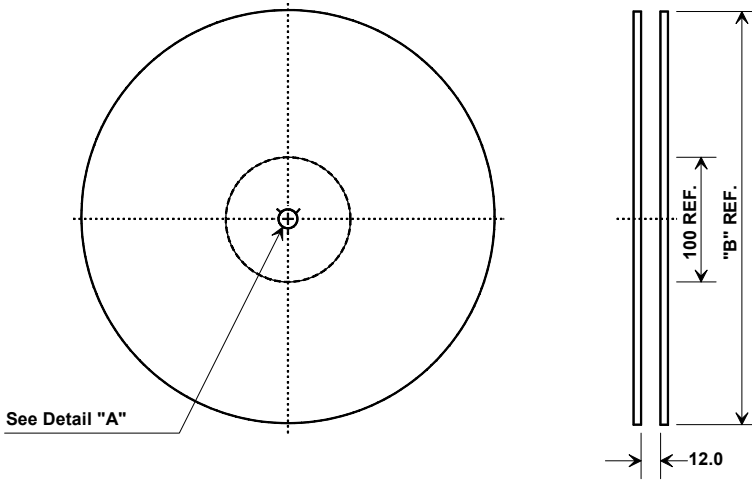

"B"		Quantity Per Reel
Inches	millimeters	
7	178	500
13	330	3000

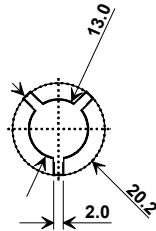

### COMPONENT ORIENTATION and DIMENSIONS

Carrier Tape Dimensions	
<b>Ao</b>	3.35 mm
<b>Bo</b>	3.35 mm
<b>Ko</b>	1.4 mm
<b>Pitch</b>	8.0 mm
<b>W</b>	12.0 mm

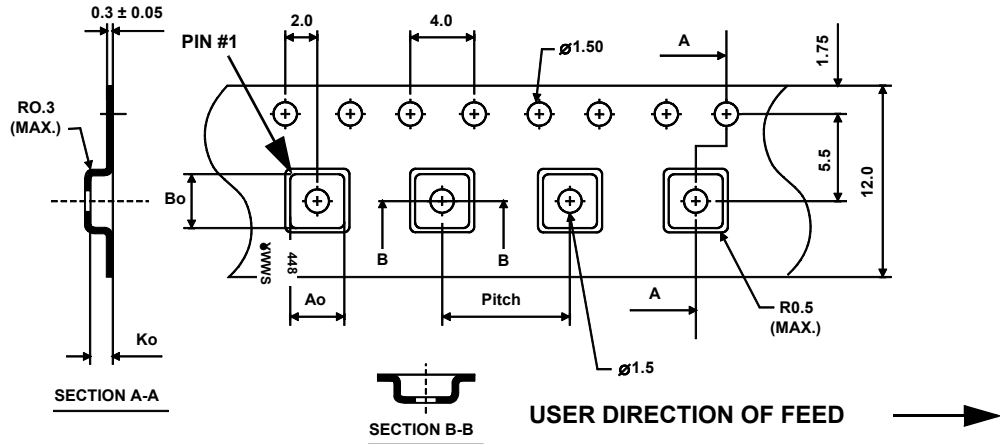

## Recommended Reflow Profile

1. Preheating shall be fixed at 150~180°C for 60~90 seconds.
2. Ascending time to preheating temperature 150°C shall be 30 seconds min.
3. Heating shall be fixed at 220°C for 50~80 seconds and at 260°C+0/-5°C peak (10 seconds).
4. Time: 5 times maximum.

