



- *Low-loss RF SAW Filter*
- *3.0 x 3.0 x 1.4 mm Surface-mount Case*
- *No Matching Required for 50Ω Operation*
- *Moisture Sensitivity Level: 1*

RoHS
Compliant

SF2251E

**1600 MHz
SAW Filter**

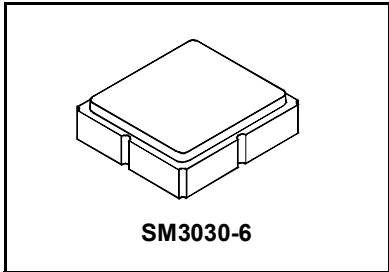

Absolute Maximum Ratings

Rating	Value	Units
Incident Power in Passband	+10	dBm
DC Voltage on any Non-ground Terminal	3	VDC
Operating Temperature Range	-55 to +85	°C
Storage Temperature Range in Tape and Reel	-55 to +95	°C
Maximum Soldering Profile, 5 cycles/10 seconds maximum	260	°C

Electrical Characteristics

Characteristic	Sym	Notes	Min	Typ	Max	Units
Center Frequency	f_c			1600		MHz
Insertion Loss, 1580 to 1620 MHz	IL			3.15	5.00	dB
1500 MHz Attenuation Referenced to 0 dB			45	64		dB
1700 MHz Attenuation Referenced to 0 dB			40	47		dB
Terminating Source Impedance	Z_s			50		Ω
Terminating Load Impedance	Z_L			50		Ω
Input/Output Impedance Match	No matching network required for 50 ohm source/load					
Case Style	SM3030-6					
Lid Symbolization: Y = year, WW = week, S = shift	992, <u>YWWS</u>					

CAUTION: Electrostatic Sensitive Device. Observe precautions for handling.
NOTES:

1. The design, manufacturing process, and specifications of this device are subject to change.
2. US or International patents may apply.
3. RoHS compliant from the first date of manufacture.

Matching Circuit

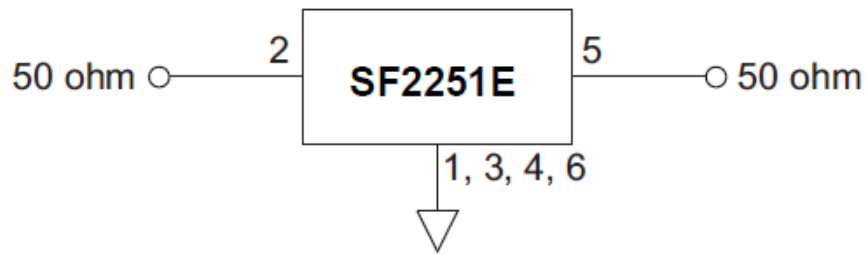

Frequency Response Plots

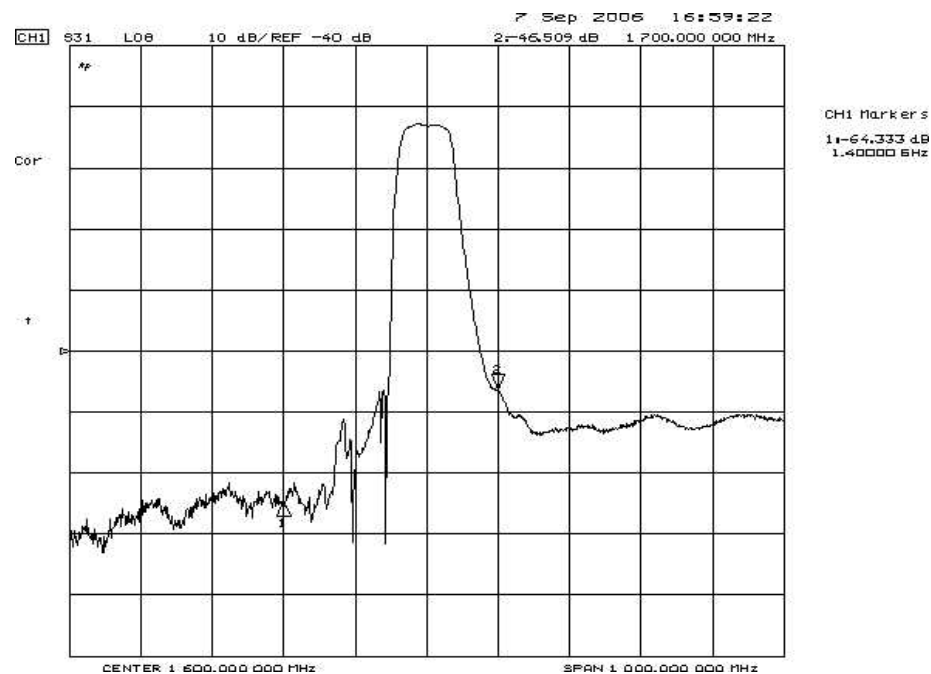
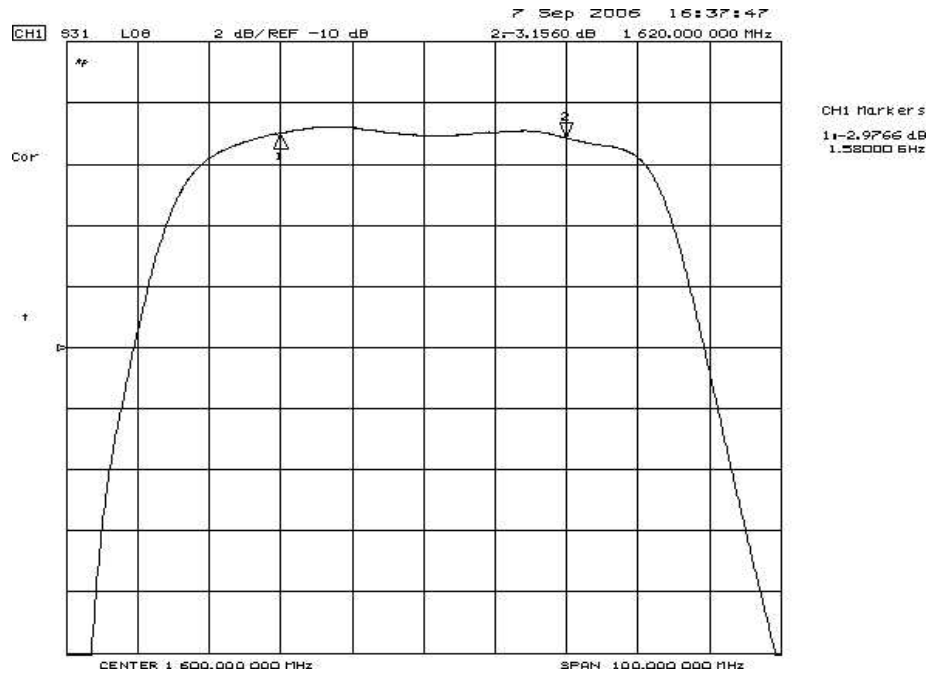

Input/Output Impedance Plots

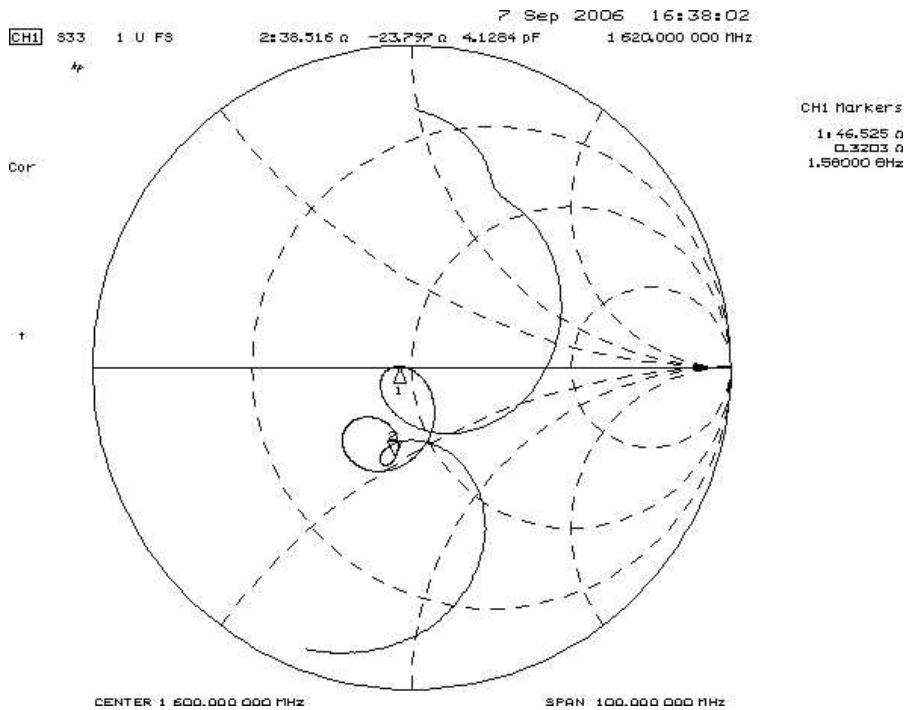
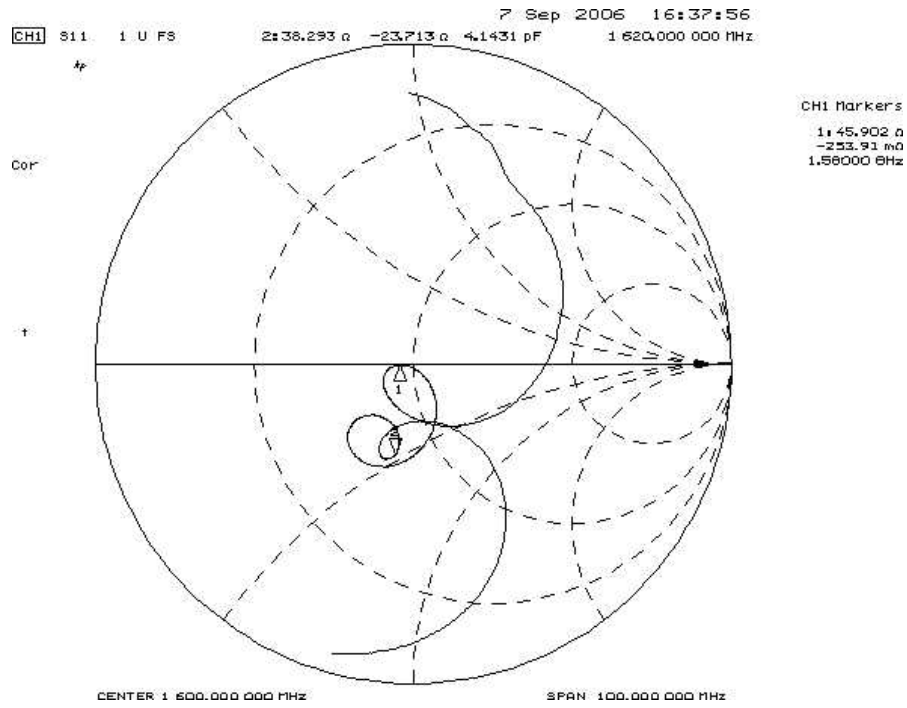

6-Terminal Ceramic Surface-Mount Case 3.0 X 3.0 mm Nominal Footprint

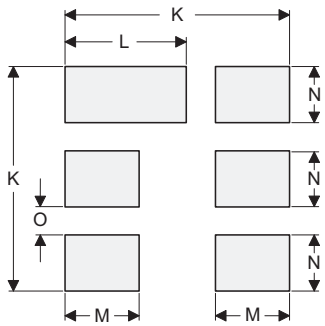
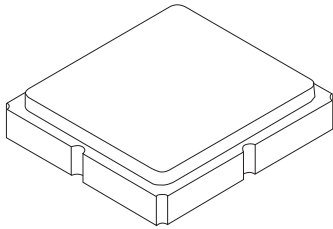

PCB Footprint Top View

Case and PCB Footprint Dimensions

Dimension	mm			Inches		
	Min	Nom	Max	Min	Nom	Max
A	2.87	3.00	3.13	0.113	0.118	0.123
B	2.87	3.00	3.13	0.113	0.118	0.123
C	1.12	1.25	1.38	0.044	0.049	0.054
D	0.77	0.90	1.03	0.030	0.035	0.040
E	2.67	2.80	2.93	0.105	0.110	0.115
F	1.47	1.60	1.73	0.058	0.063	0.068
G	0.72	0.85	0.98	0.028	0.033	0.038
H	1.37	1.50	1.63	0.054	0.059	0.064
I	0.47	0.60	0.73	0.019	0.024	0.029
J	1.17	1.30	1.43	0.046	0.051	0.056
K		3.20			0.126	
L		1.70			0.067	
M		1.05			0.041	
N		0.81			0.032	
O		0.38			0.015	

Case Materials

Materials	
Solder Pad Plating	0.3 to 1.0 μm Gold over 1.27 to 8.89 μm Nickel
Lid Plating	2.0 to 3.0 μm Nickel
Body	Al_2O_3 Ceramic

TOP VIEW

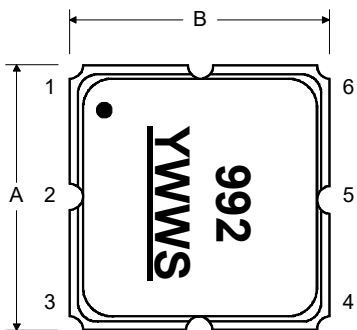

BOTTOM VIEW

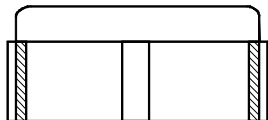
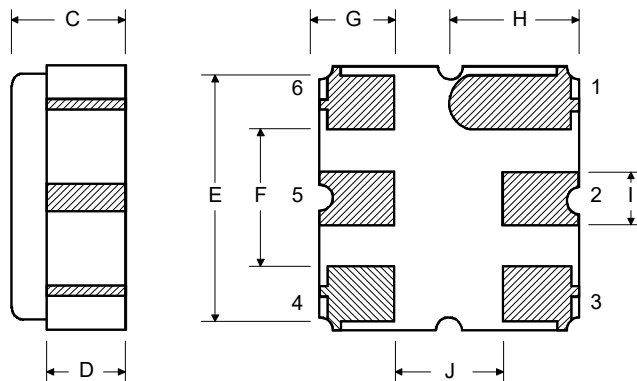

Tape and Reel Specifications

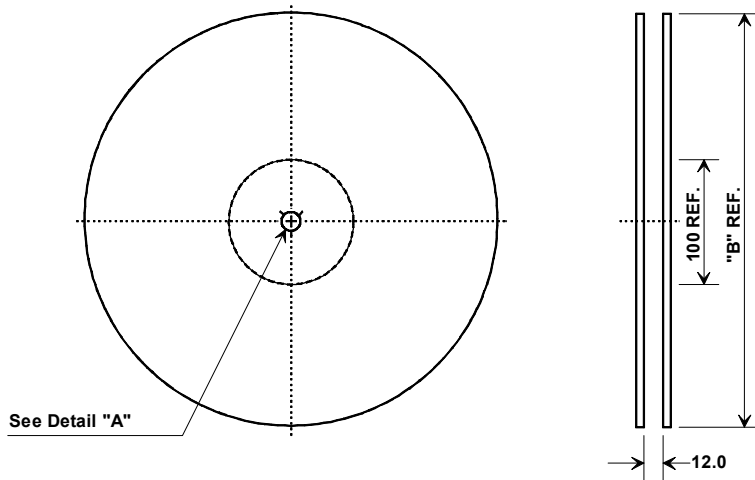

Tape and Reel Standard per ANSI/EIA-481

"B"		Quantity Per Reel
Inches	millimeters	
7	178	500
13	330	3000

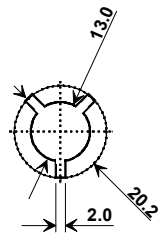

COMPONENT ORIENTATION and DIMENSIONS

Carrier Tape Dimensions	
Ao	3.35 mm
Bo	3.35 mm
Ko	1.40 mm
Pitch	8.0 mm
W	12.0 mm

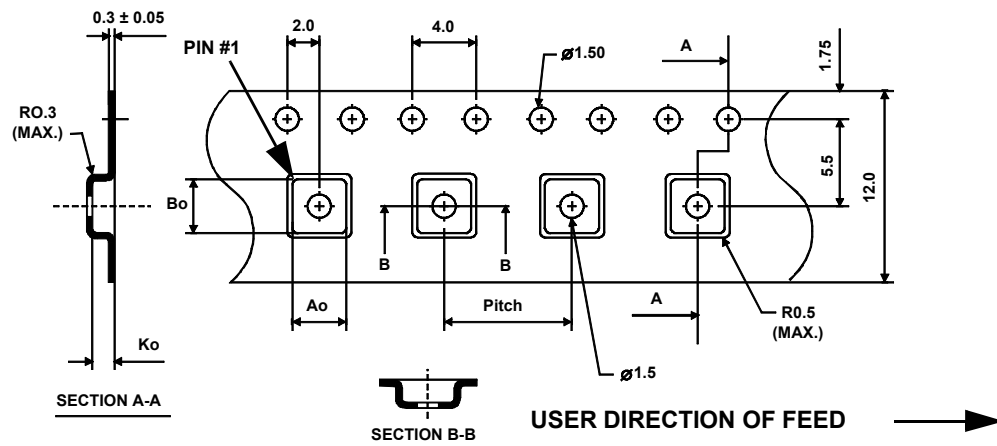

Recommended Reflow Profile

1. Preheating shall be fixed at 150~180°C for 60~90 seconds.
2. Ascending time to preheating temperature 150°C shall be 30 seconds min.
3. Heating shall be fixed at 220°C for 50~80 seconds and at 260°C +0/-5°C peak (10 seconds).
4. Time: 5 times maximum.

